

Typical Unit

Features

- Step-down buck regulators with industry-standard SMT footprint
- 5V input (4.5-5.5V range)
- 0.8/1/1.2/1.5/1.8/2/2.5/3.3V_{OUT} @ 10A
- Non-isolated, fixed-frequency, synchronous-rectifier topology
- Tape and reel SMT package
- ±1% setpoint accuracy
- Efficiencies to 95% @ 10 Amps
- Noise as low as 30mVp-p
- Stable no-load operation
- Remote on/off control
- Sense pin and output voltage trim
- Thermal shutdown
- No derating to +71°C, natural convection
- UL/IEC/EN60950 certified
- EMC compliant

DATEL's LSM D5 Series for SMT (surface-mount) are non-isolated DC/DC converters that accept a 5V input (4.5V to 5.5V input range) and deliver 0.8V, 1V, 1.2V, 1.5V, 1.8V, 2V, 2.5V, or 3.3V outputs at 10 Amps. LSM D5 SMT's are designed to take on-board 5V power and convert it, with the highest efficiency in the smallest space, to any lower voltage required by today's current-hungry DSP's, ASIC's and CPLD's.

The LSM D5's miniature size makes them ideal for true point-of-use/ load power processing. They occupy a mere 0.7 square inches (4.5 cm²) and are only 0.34 inches (8.64 mm) high. The SMT package is designed for pick and place including lead free reflow soldering, and they typically require no additional external components.

The LSM's best-in-class power density is achieved with a fully synchronous, fixed-frequency (300kHz), buck topology that also delivers: high efficiency (95% for 3.3V_{OUT} models), low noise (30mVp-p typ.), tight line/ load regulation (±0.1%/±0.25% max.), quick step response (100µsec), stable no-load operation, and no output reverse conduction.

The fully functional LSM's feature output overcurrent detection, continuous short-circuit and over-temperature protection, an output-voltage trim function, a remote on/off control pin (pull low to disable), and a sense pin. High efficiency enables the LSM D5's to deliver rated output currents of 10 Amps at ambient temperatures to +71°C with no air flow (natural convection).

If your low-voltage, high-current requirements have made the use of inefficient linear regulators impractical, take a look at one of DATEL's easy-to-use, low-cost LSM SMT's (or equivalent LSN SIP's). All devices are UL/IEC/EN60950 certified and EMC compliant. UL, CB, HALT and EMC reports are available upon request.

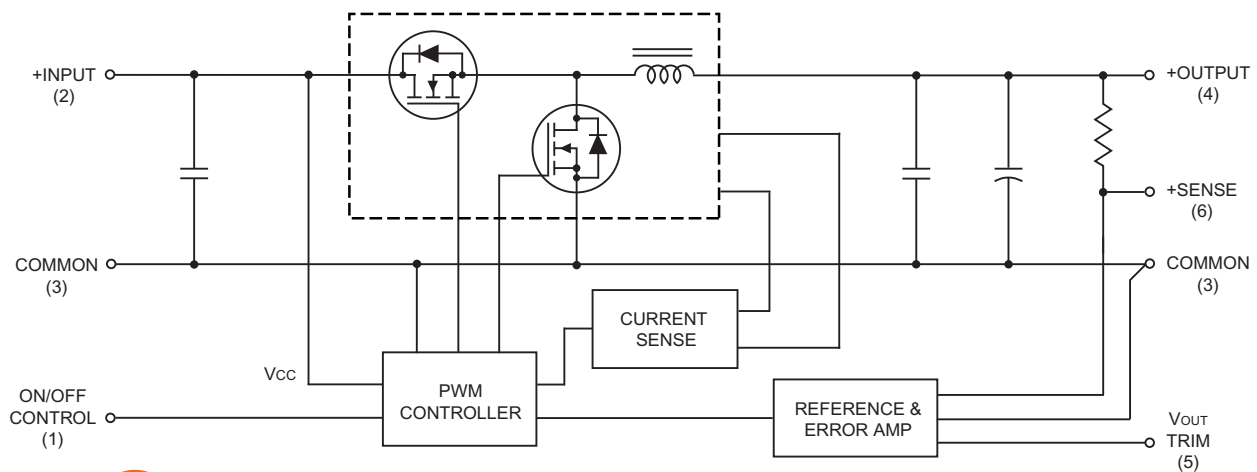

Figure 1. Simplified Schematic



Performance Specifications and Ordering Guide ^①

Model	Output						Input			Efficiency			Package (Case, Pinout)
	V _{OUT} (Volts)	I _{OUT} (Amps)	R/N (mVp-p) ^②		Regulation (Max.) ^③		V _{IN} Nom. (Volts)	Range (Volts)	I _{IN} ^④ (mA/A)	Full Load		½ Load	
			Typ.	Max.	Line	Load				Min.	Typ.	Typ.	
LSM-0.8/10-D5 ^⑤	0.8	10	30	50	±0.1%	±0.25%	5	4.5-5.5	50/2	81%	84%	85%	C45, P63
LSM-1/10-D5	1	10	20	50	±0.1%	±0.25%	5	4.5-5.5	50/2.43	83.5%	85.5%	89%	C45, P63
LSM-1.2/10-D5	1.2	10	30	50	±0.1%	±0.25%	5	4.5-5.5	50/2.85	85.5%	87.5%	91%	C45, P63
LSM-1.5/10-D5	1.5	10	30	50	±0.1%	±0.25%	5	4.5-5.5	50/3.48	87.5%	89.5%	92%	C45, P63
LSM-1.8/10-D5	1.8	10	30	50	±0.1%	±0.25%	5	4.5-5.5	50/4.09	89%	91%	93%	C45, P63
LSM-2/10-D5	2	10	30	50	±0.1%	±0.25%	5	4.5-5.5	50/4.51	90%	92%	94%	C45, P63
LSM-2.5/10-D5	2.5	10	30	50	±0.1%	±0.25%	5	4.5-5.5	50/5.5	91.5%	93.5%	95%	C45, P63
LSM-3.3/10-D5	3.3	10	30	50	±0.1%	±0.25%	5	4.5-5.5	50/7.25	93%	95%	96%	C45, P63

① Typical at T_A = +25°C under nominal line voltage and full-load conditions, unless otherwise noted. All models are tested and specified with external 22µF tantalum input and output capacitors. These capacitors are necessary to accommodate our test equipment and may not be required to achieve specified performance in your applications. See I/O Filtering and Noise Reduction.
 ② Ripple/Noise (R/N) is tested/specified over a 20MHz bandwidth and may be reduced with external filtering. See I/O Filtering and Noise Reduction for details.

③ These devices have no minimum-load requirements and will regulate under no-load conditions. Regulation specifications describe the output-voltage deviation as the line voltage or load is varied from its nominal/midpoint value to either extreme.
 ④ Nominal line voltage, no-load/full-load conditions.
 ⑤ Contact Murata Power Solutions Technologies (DATEL) for availability.

PART NUMBER STRUCTURE

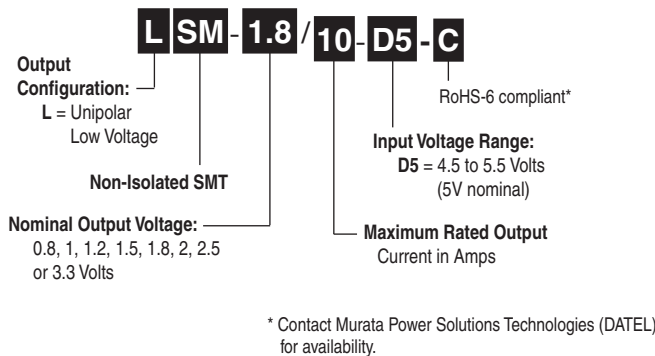

MECHANICAL SPECIFICATIONS

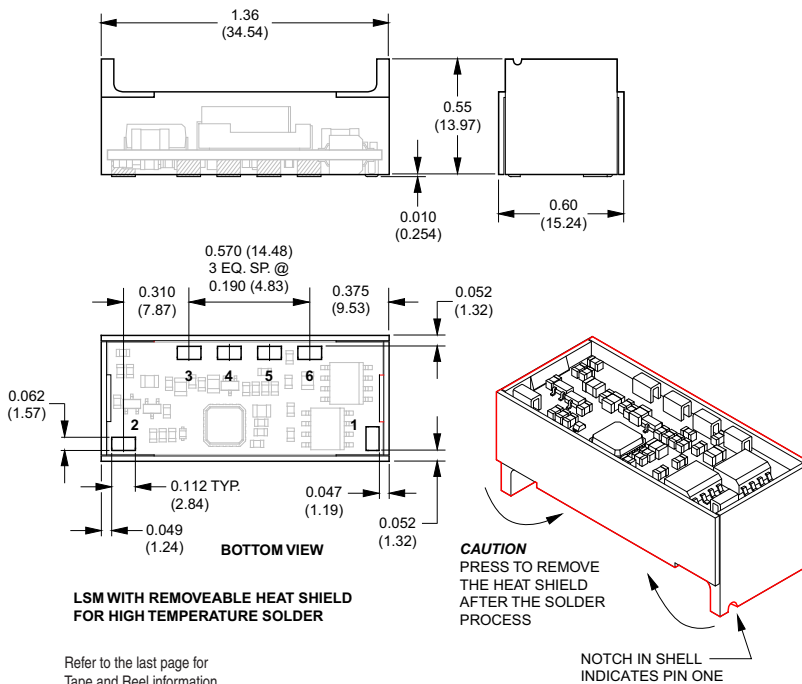
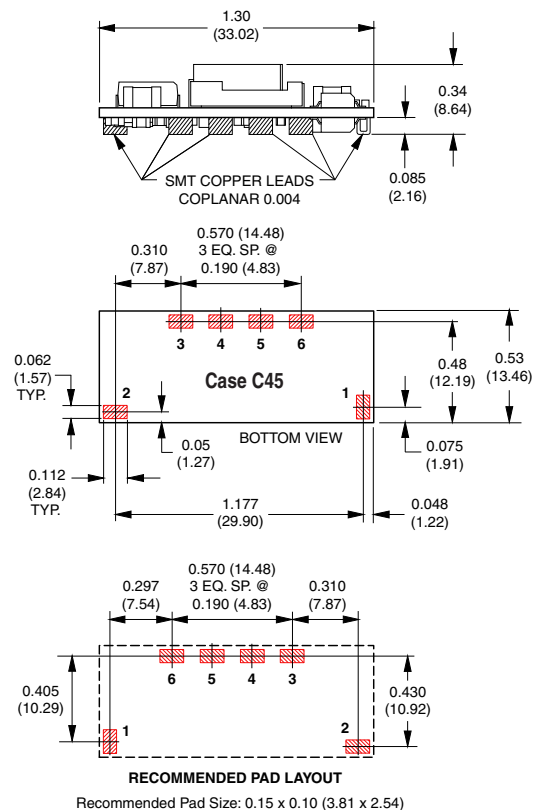

I/O Connections	
Pin	Function P63
1	On/Off Control
2	+Input
3	Common
4	+Output
5	V _{OUT} Trim
6	+Sense

Refer to the last page for Tape and Reel information.

Performance/Functional Specifications

Typical @ TA = +25°C under nominal line voltage and full-load conditions unless noted. ①

Input	
Input Voltage Range	4.5 to 5.5 Volts (5V nominal)
Input Current:	
Normal Operating Conditions	See Ordering Guide
Inrush Transient	0.02A ² sec
Standby/Off Mode	5mA
Output Short-Circuit Condition ②	60mA average
Input Reflected Ripple Current ②	20mA _{p-p}
Input Filter Type	Capacitive (44μF)
Overvoltage Protection	None
Reverse-Polarity Protection	None
Undervoltage Shutdown	None
On/Off Control ② ③	On = open (internal pull-up to +VIN) Off = 0 to +0.8V (1ma max.)
Output	
VOUT Accuracy (50% load)	±1% maximum
Minimum Loading ①	No load
Maximum Capacitive Load	1000μF (low ESR, OSCON)
VOUT Trim Range ②	±10% (0.8V not trimmable)
Ripple/Noise (20MHz BW) ① ② ④	See Ordering Guide
Total Accuracy	3% over line/load temperature
Efficiency ②	See Ordering Guide
Overcurrent Detection and Short-Circuit Protection: ②	
Current-Limiting Detection Point	17 (13-23.5) Amps
Short-Circuit Detection Point	98% of VOUT set
SC Protection Technique	Hiccup with auto recovery
Short-Circuit Current	600mA average
Dynamic Characteristics	
Transient Response (50% load step)	100μsec to ±2% of final value
Start-Up Time: ②	
VIN to VOUT	7msec
On/Off to VOUT	6msec
Switching Frequency:	300kHz (+40/-50kHz)
Environmental	
Calculated MTBF ⑤	2.3-1.8 million hours (1VOUT to 5VOUT)
Operating Temperature: (Ambient) ②	
Without Derating (Natural convection)	-40 to +63/71°C (model dependent)
With Derating	See Derating Curves
Thermal Shutdown	+115°C (110 to 125°C)
Physical	
Dimensions	1.3" x 0.53" x 0.34" (33.02 x 13.46 x 8.64 mm)
Pin Dimensions/Material	0.112" x 0.062" (2.84 x 1.57mm) rectangular copper with gold plate over nickel underplate
Weight	0.28 ounces (7.8g)
Flamability Rating	UL94V-0
Safety	UL/cUL/IEC/EN 60950, CSA-C22.2 No. 234

- ① All models are tested and specified with external 22μF tantalum input and output capacitors. These capacitors are necessary to accommodate our test equipment and may not be required to achieve specified performance in your applications. All models are stable and regulate within spec under no-load conditions.
- ② See Technical Notes and Performance Curves for details.
- ③ The On/Off Control (pin 1) is designed to be driven with open-collector logic or the application of appropriate voltages (referenced to Common, pin 3). Applying a voltage to On/Off Control when no input voltage is applied to the converter may cause permanent damage.
- ④ Output noise may be further reduced with the installation of additional external output filtering. See I/O Filtering and Noise Reduction.
- ⑤ MTBF's are calculated using Telcordia SR-332(Bellcore), ground fixed, TA = +25°C, full power, natural convection, +67°C pcb temperature.

Absolute Maximum Ratings

Input Voltage:	
Continuous or transient	7 Volts
On/Off Control (Pin 1)	+VIN
Input Reverse-Polarity Protection	None
Output Overvoltage Protection	None
Output Current	Current limited. Devices can withstand sustained output short circuits without damage.
Storage Temperature	-40 to +125°C
Lead Temperature (soldering, 10 sec.)	See Reflow Solder Profile

These are stress ratings. Exposure of devices to any of these conditions may adversely affect long-term reliability. Proper operation under conditions other than those listed in the Performance/Functional Specifications Table is not implied.

TECHNICAL NOTES

I/O Filtering and Noise Reduction

All models in the LSM D5 Series are tested and specified with external 22μF tantalum input and output capacitors. These capacitors are necessary to accommodate our test equipment and may not be required to achieve desired performance in your application. The LSM D5's are designed with high-quality, high-performance *internal* I/O caps, and will operate within spec in most applications with *no additional external components*.

In particular, the LSM D5's input capacitors are specified for low ESR and are fully rated to handle the units' input ripple currents. Similarly, the internal output capacitors are specified for low ESR and full-range frequency response. As shown in the Performance Curves, removal of the external 22μF tantalum output caps has minimal effect on output noise.

In critical applications, input/output ripple/noise may be further reduced using filtering techniques, the simplest being the installation of external I/O caps.

External input capacitors serve primarily as energy-storage devices. They minimize high-frequency variations in input voltage (usually caused by IR drops in conductors leading to the DC/DC) as the switching converter draws pulses of current. Input capacitors should be selected for bulk capacitance (at appropriate frequencies), low ESR, and high rms-ripple-current ratings. The switching nature of modern DC/DC's requires that the dc input voltage source have low ac impedance at the frequencies of interest. Highly inductive source impedances can greatly affect system stability. Your specific system configuration may necessitate additional considerations.

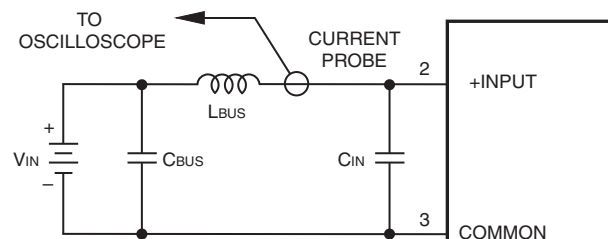

CIN = 33μF, ESR < 700mΩ @ 100kHz
 CBUS = 220μF, ESR < 100mΩ @ 100kHz
 LBUS = 12μH

LSM-T/10-D12 Filters:

CIN = 2 x 100μF, CBUS = 1000μF
 LBUS = 1μH

Figure 2. Measuring Input Ripple Current

Output ripple/noise (also referred to as periodic and random deviations or PARD) may be reduced below specified limits with the installation of additional external output capacitors. Output capacitors function as true filter elements and should be selected for bulk capacitance, low ESR, and appropriate frequency response. Any scope measurements of PARD should be made directly at the DC/DC output pins with scope probe ground less than 0.5" in length.

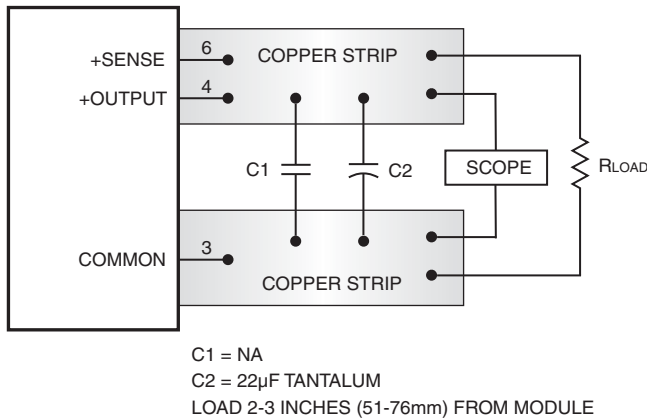

Figure 3. Measuring Output Ripple/Noise (PARD)

All external capacitors should have appropriate voltage ratings and be located as close to the converters as possible. Temperature variations for all relevant parameters should be taken into consideration.

The most effective combination of external I/O capacitors will be a function of your line voltage and source impedance, as well as your particular load and layout conditions. Our Applications Engineers can recommend potential solutions and discuss the possibility of our modifying a given device's internal filtering to meet your specific requirements. Contact our Applications Engineering Group for additional details.

Input Fusing

Most applications and or safety agencies require the installation of fuses at the inputs of power conversion components. LSM D5 Series DC/DC converters are not internally fused. Therefore, if input fusing is mandatory, either a normal-blow or a fast-blow fuse with a value no greater than 15 Amps should be installed within the ungrounded input path to the converter.

As a rule of thumb however, we recommend to use a normal-blow or slow-blow fuse with a typical value of about twice the maximum input current, calculated at low line with the converters minimum efficiency.

Safety Considerations

LSM D5 SMT's are non-isolated DC/DC converters. In general, all DC/DC's must be installed, including considerations for I/O voltages and spacing/separation requirements, in compliance with relevant safety-agency specifications (usually UL/IEC/EN60950).

In particular, for a non-isolated converter's output voltage to meet SELV (safety extra low voltage) requirements, its input must be SELV compliant. If the output needs to be ELV (extra low voltage), the input must be ELV.

Input Overvoltage and Reverse-Polarity Protection

LSM D5 SMT Series DC/DC's do not incorporate either input overvoltage or input reverse-polarity protection. Input voltages in excess of the specified absolute maximum ratings and input polarity reversals of longer than "instantaneous" duration can cause permanent damage to these devices.

Start-Up Time

The VIN to VOUT Start-Up Time is the interval between the time at which a ramping input voltage crosses the lower limit of the specified input voltage range (4.5 Volts) and the fully loaded output voltage enters and remains within its specified accuracy band. Actual measured times will vary with input source impedance, external input capacitance, and the slew rate and final value of the input voltage as it appears to the converter.

The On/Off to VOUT Start-Up Time assumes the converter is turned off via the On/Off Control with the nominal input voltage already applied to the converter. The specification defines the interval between the time at which the converter is turned on and the fully loaded output voltage enters and remains within its specified accuracy band. See Typical Performance Curves.

Remote Sense

LSM D5 SMT Series DC/DC converters offer an output sense function on pin 6. The sense function enables point-of-use regulation for overcoming moderate IR drops in conductors and/or cabling. Since these are non-isolated devices whose inputs and outputs usually share the same ground plane, sense is provided only for the +Output.

The remote sense line is part of the feedback control loop regulating the DC/DC converter's output. The sense line carries very little current and consequently requires a minimal cross-sectional-area conductor. As such, it is not a low-impedance point and must be treated with care in layout and cabling. Sense lines should be run adjacent to signals (preferably ground), and in cable and/or discrete-wiring applications, twisted-pair or similar techniques should be used. To prevent high frequency voltage differences between VOUT and Sense, we recommend installation of a 1000pF capacitor close to the converter.

The sense function is capable of compensating for voltage drops between the +Output and +Sense pins that do not exceed 10% of VOUT.

$$[V_{OUT(+)} - Common] - [Sense(+)- Common] \leq 10\%V_{OUT}$$

Power derating (output current limiting) is based upon maximum output current and voltage at the converter's output pins. Use of trim and sense functions can cause the output voltage to increase, thereby increasing output power beyond the LSM's specified rating. Therefore:

$$(V_{OUT \text{ at pins}}) \times (I_{OUT}) \leq \text{rated output power}$$

The internal 10.5Ω resistor between +Sense and +Output (see Figure 1) serves to protect the sense function by limiting the output current flowing through the sense line if the main output is disconnected. It also prevents output voltage runaway if the sense connection is disconnected.

Note: If the sense function is not used for remote regulation, +Sense (pin 6) must be tied to +Output (pin 4) at the DC/DC converter pins.

On/Off Control

The On/Off Control pin may be used for remote on/off operation. LSM D5 Series DC/DC converters are designed so that they are enabled when the control pin is left open (open collector) and disabled when the control pin is pulled low (to less than +0.8V relative to Common). As shown in Figure 4, all models have an internal 5kΩ pull-up resistor to V_{IN} (+Input).

Dynamic control of the on/off function is best accomplished with a mechanical relay or open-collector/open-drain drive circuit (optically isolated if appropriate). The drive circuit should be able to sink appropriate current when activated and withstand appropriate voltage when deactivated.

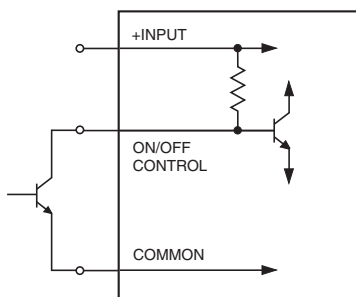

ON/OFF pin open: Logic High = DC/DC converter On
ON/OFF pin <0.4V: Logic Low = DC/DC converter Off

Figure 4. Driving the On/Off Control Pin with an Open-Collector Drive Circuit

Applying an external voltage to the On/Off Control pin when no input power is applied to the converter can cause permanent damage to the converter. The on/off control function, however, is designed such that the converter can be disabled (control pin pulled low) while input voltage is ramping up and then "released" once the input has stabilized (see also power-up sequencing).

Power-up sequencing

If a controlled start-up of one or more LSM D5 Series DC/DC converters is required, or if several output voltages need to be powered-up in a given sequence, the On/Off control pin can be driven with an external open collector device as per Figure 5.

Leaving the input of the external circuit open during power-up will have the output of the DC/DC converter disabled. When the input to the external open collector is pulled low, the DC/DC converters output will be enabled.

Output Overvoltage Protection

LSM D5 SMT Series DC/DC converters do not incorporate output overvoltage protection. In the extremely rare situation in which the device's feedback loop is broken, the output voltage may run to excessively high levels (V_{OUT} = V_{IN}). If it is absolutely imperative that you protect your load against any and all possible overvoltage situations, voltage limiting circuitry must be provided external to the power converter.

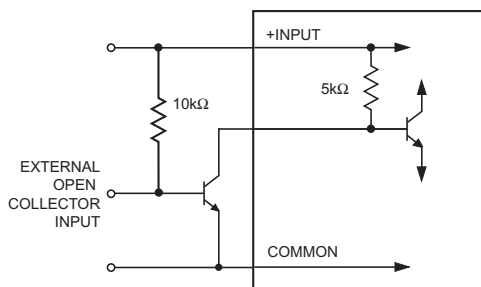

External Input Open: On/Off pin Low = DC/DC converter Off
External Input Low: On/Off pin High = DC/DC converter On

Figure 5. Driving the External Power-Up Open Collector

Output Overcurrent Detection

Overloading the power converter's output for an extended time will invariably cause internal component temperatures to exceed their maximum ratings and eventually lead to component failure. High-current-carrying components such as inductors, FET's and diodes are at the highest risk. LSM D5 SMT Series DC/DC converters incorporate an output overcurrent detection and shutdown function that serves to protect both the power converter and its load.

If the output current exceeds its maximum rating by typically 70% (17 Amps) or if the output voltage drops to less than 98% of its original value, the LSM D5's internal overcurrent-detection circuitry immediately turns off the converter, which then goes into a "hiccup" mode. While hiccupping, the converter will continuously attempt to restart itself, go into overcurrent, and then shut down. Under these conditions, the average output current will be approximately 600mA, and the average input current will be approximately 60mA. Once the output short is removed, the converter will automatically restart itself.

Output Voltage Trimming

Allowable trim ranges for each model in the LSM D5 SMT Series are ±10%. Trimming is accomplished with either a trimpot or a single fixed resistor. The trimpot should be connected between +Output and Common with its wiper connected to the Trim pin as shown in Figure 6 below.

A trimpot can be used to determine the value of a single fixed resistor which can then be connected, as shown in Figure 7, between the Trim pin and +Output to trim down the output voltage, or between the Trim pin and Common to trim up the output voltage. Fixed resistors should have absolute TCR's less than 100ppm/°C to ensure stability.

The equations below can be starting points for selecting specific trim-resistor values. Recall, untrimmed devices are guaranteed to be ±1% accurate.

Adjustment beyond the specified ±10% adjustment range is not recommended. When using trim in combination with Remote Sense, the maximum rated power must not be exceeded (see Remote Sense).

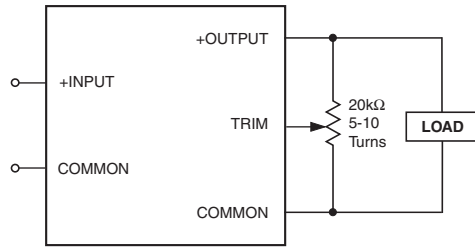

Figure 6. Trim Connections Using a Trimpot

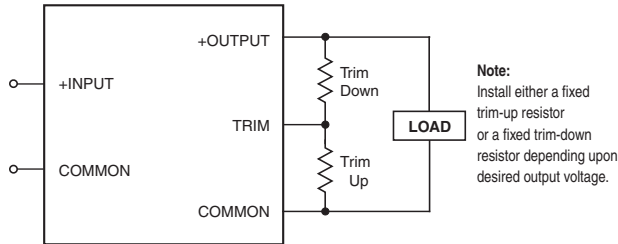

Figure 7. Trim Connections Using Fixed Resistors

Trim Equations

Model	Trim Equations
LSM-1/10-D5	$R_{T_DOWN} (k\Omega) = \frac{1.62(V_O - 0.8)}{1 - V_O} - 1$ $R_{T_UP} (k\Omega) = \frac{1.296}{V_O - 1} - 1$
LSM-1.2/10-D5	$R_{T_DOWN} (k\Omega) = \frac{2.49(V_O - 0.8)}{1.2 - V_O} - 2.37$ $R_{T_UP} (k\Omega) = \frac{1.992}{V_O - 1.2} - 2.37$
LSM-1.5/10-D5 LSM-1.8/10-D5 LSM-2/10-D5 LSM-2.5/10-D5	$R_{T_DOWN} (k\Omega) = \frac{2.37(V_O - 0.8)}{V_{O_NOM} - V_O} - 4.99$ $R_{T_UP} (k\Omega) = \frac{1.896}{V_O - V_{O_NOM}} - 4.99$
LSM-3.3/10-D5	$R_{T_DOWN} (k\Omega) = \frac{7.5(V_O - 0.8)}{V_{O_NOM} - V_O} - 4.99$ $R_{T_UP} (k\Omega) = \frac{6}{V_O - V_{O_NOM}} - 4.99$

Note: Resistor values are in kΩ. Accuracy of adjustment is subject to tolerances of resistors and factory-adjusted, initial output accuracy.

V_O = desired output voltage. V_{O,NOM} = nominal output voltage.

Note: LSM-0.8/10-D5 is not trimmable.

Output Reverse Conduction

Many DC/DC's using synchronous rectification suffer from Output Reverse Conduction. If those devices have a voltage applied across their output before a voltage is applied to their input (this typically occurs when another power supply starts before them in a power-sequenced application), they will either fail to start or self destruct. In both cases, the cause is the "freewheeling" or "catch" FET biasing itself on and effectively becoming a short circuit.

LSM D5 SMT DC/DC converters do not suffer from Output Reverse Conduction. They employ proprietary gate drive circuitry that makes them immune to applied output voltages.

Thermal Considerations and Thermal Protection

The typical output-current thermal-derating curves shown below enable designers to determine how much current they can reliably derive from each model of the LSM D5 SMT's under known ambient-temperature and air-flow conditions. Similarly, the curves indicate how much air flow is required to reliably deliver a specific output current at known temperatures.

The highest temperatures in LSM D5 SMT's occur at their output inductor, whose heat is generated primarily by I²R losses. The derating curves were developed using thermocouples to monitor the inductor temperature and varying the load to keep that temperature below +110°C under the assorted conditions of air flow and air temperature. Once the temperature exceeds +115°C (approx.), the thermal protection will disable the converter. Automatic restart occurs after the temperature has dropped below +110°C.

As you may deduce from the derating curves and observe in the efficiency curves on the following pages, LSM D5 SMT's are more efficient at lower current levels. Also I²R losses in the output inductor are significantly less at lower current levels. Consequently, LSN-D5 SMT's deliver very impressive temperature performance if operating at less than full load.

Lastly, when LSM D5 SMT's are installed in system boards, they are obviously subject to numerous factors and tolerances not taken into account here. If you are attempting to extract the most current out of these units under demanding temperature conditions, we advise you to monitor the output-inductor temperature to ensure it remains below +110°C at all times.

Start Up Considerations

When power is first applied to the DC/DC converter, operation is different than when the converter is running and stabilized. There is some risk of start up difficulties if you do not observe several application features. Lower input voltage converters may have more problems here since they tend to have higher input currents. Operation is most critical with any combination of the following external factors:

- 1 - Low initial input line voltage and/or poor regulation of the input source.
- 2 - Full output load current on lower output voltage converters.
- 3 - Slow slew rate of input voltage.
- 4 - Longer distance to input voltage source and/or higher external input source impedance.
- 5 - Limited or insufficient ground plane. External wiring that is too small.
- 6 - Too small external input capacitance. Too high ESR.
- 7 - High output capacitance causing a start up charge overcurrent surge.
- 8 - Output loads with excessive inductive reactance or constant current characteristics.

If the input voltage is already at the low limit before power is applied, the start up surge current may instantaneously reduce the voltage at the input terminals to below the specified minimum voltage. Even if this voltage depression is very brief, this may interfere with the on-board controller and possibly cause a failed start. Or the converter may start but the input current load will now drive the input voltage below its running low limit and the converter will shut down.

If you measure the input voltage before start up with a Digital Voltmeter (DVM), the voltage may appear to be adequate. Limited external capacitance and/or too high a source impedance may cause a short downward spike at power up, causing an instantaneous voltage drop. Use an oscilloscope not a DVM to observe this spike. The converter's soft-start controller is sensitive to input voltage. What matters here is the actual voltage at the input terminals at all times.

Symptoms of start-up difficulties may include failed started, output oscillation or brief start up then overcurrent shutdown. Since the input voltage is never absolutely constant, the converter may start up at some times and not at others.

Solutions

To improve start up, review the conditions above. One of the better solutions is to place a moderate size capacitor very close to the input terminals. You may need two parallel capacitors. A larger electrolytic or tantalum cap supplies the surge current and a smaller parallel low-ESR ceramic cap gives low AC impedance. Too large an electrolytic capacitor may have higher internal impedance (ESR) and/or lower the start up slew rate enough to upset the DC/DC's controller. Make sure the capacitors can tolerate reflected switching current pulses from the converter.

The capacitors will not help if the input source has poor regulation. A converter which starts successfully at 3.3 Volts will turn off if the input voltage decays to below the input voltage threshold, regardless of external capacitance.

Increase the input start up voltage if possible to raise the downward voltage spike. Also, make sure that the input voltage ramps up in a reasonably short time (less than a few milliseconds). If possible, move the input source closer to the converter to reduce ohmic losses in the input wiring. Remember that the input current is carried both by the wiring and the ground plane return. Make sure the ground plane uses adequate thickness copper. Run additional bus wire if necessary.

Any added output capacitor should use just enough capacitance (and no more) to reduce output noise at the load and to avoid marginal threshold noise problems with external logic. An output cap will also "decouple" inductive reactance in the load. Certain kinds of electronic loads include "constant current" characteristics which destabilize the output with insufficient capacitance. If the wiring to the eventual load is long, consider placing this decoupling cap at the load. Use the Remote Sense input to avoid ohmic voltage drop errors.

An elegant solution to start up problems is to apply the input voltage with the Remote On/Off control first in the off setting (for those converters with an On/Off Control). After the specified start-up delay (usually under 20 mSec), turn on the converter. The controller will have already been stabilized. The short delay will not be noticed in most applications. Be aware of applications which need "power management" (phased start up).

Finally, it is challenging to model some application circuits with absolute fidelity. How low is the resistance of your ground plane? What is the inductance (and distributed capacitance) of external wiring? Even a detailed mathematical model may not get all aspects of your circuit. Therefore it is difficult to give cap values which serve all applications. Some experimentation may be required.

Typical Performance Curves for LSM-10A D5 SMT Series

LSM-1/10-D5
Efficiency vs. Line Voltage and Load Current

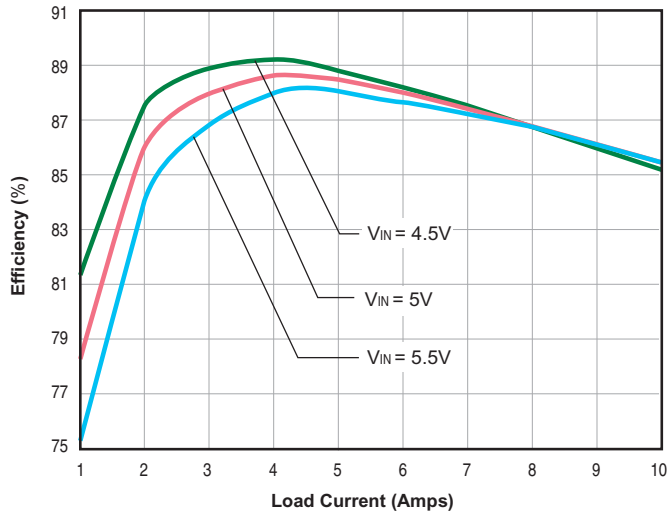

LSM-1/10-D5
Output Current vs. Ambient Temperature
(SMT mount, air flow direction from pin 2 to pin 1)

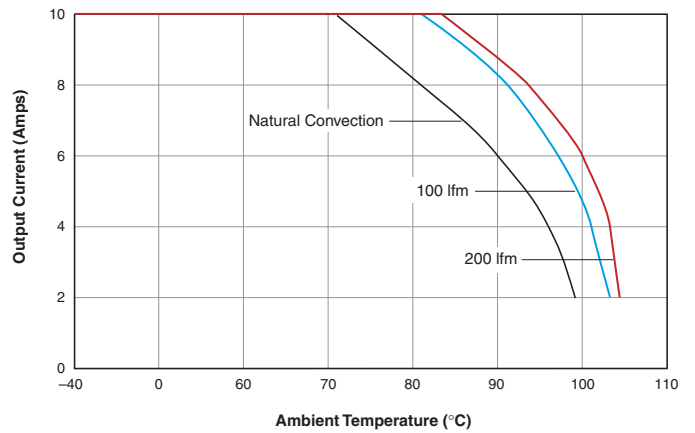

LSM-1.2/10-D5
Efficiency vs. Line Voltage and Load Current

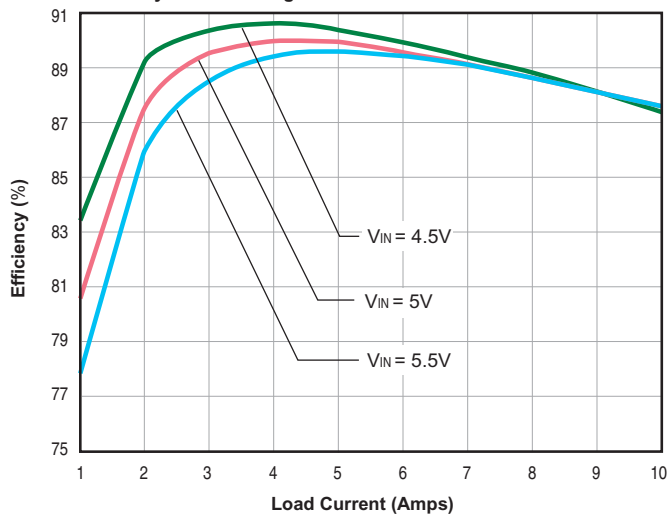

LSM-1.2/10-D5
Output Current vs. Ambient Temperature
(SMT mount, air flow direction from pin 2 to pin 1)

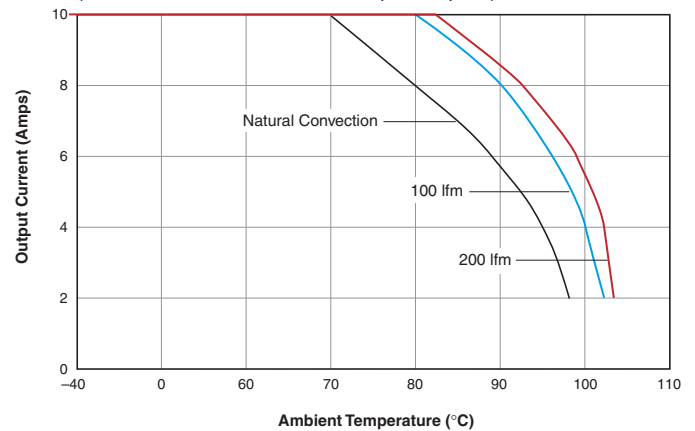

LSM-1.5/10-D5
Efficiency vs. Line Voltage and Load Current

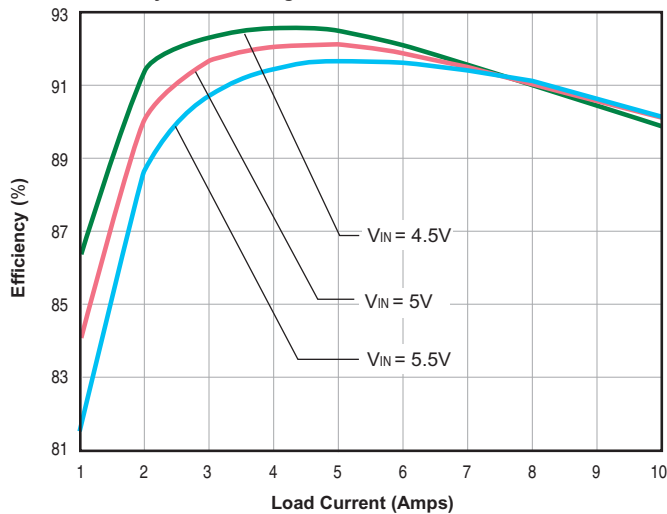

LSM-1.5/10-D5
Output Current vs. Ambient Temperature
(SMT mount, air flow direction from pin 2 to pin 1)

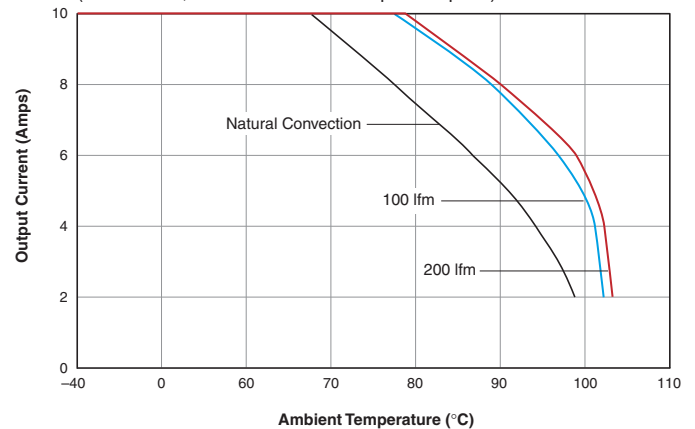

Typical Performance Curves for LSM-10A D5 SMT Series

LSM-1.8/10-D5 & LSM-2/10-D5
Output Current vs. Ambient Temperature
 (SMT mount, air flow direction from pin 2 to pin 1)

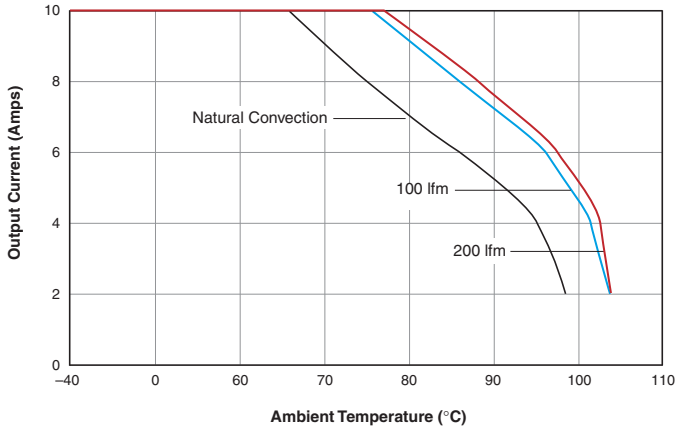

LSM-2.5/10-D5 & LSM-3.3/10-D5
Output Current vs. Ambient Temperature
 (SMT mount, air flow direction from pin 2 to pin 1)

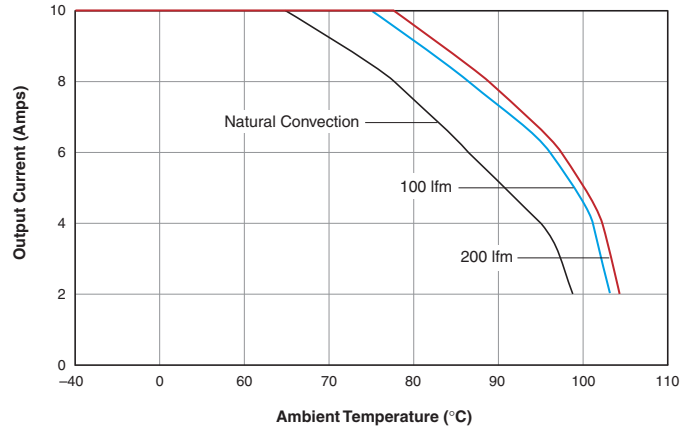

LSM-1.8/10-D5
Efficiency vs. Line Voltage and Load Current

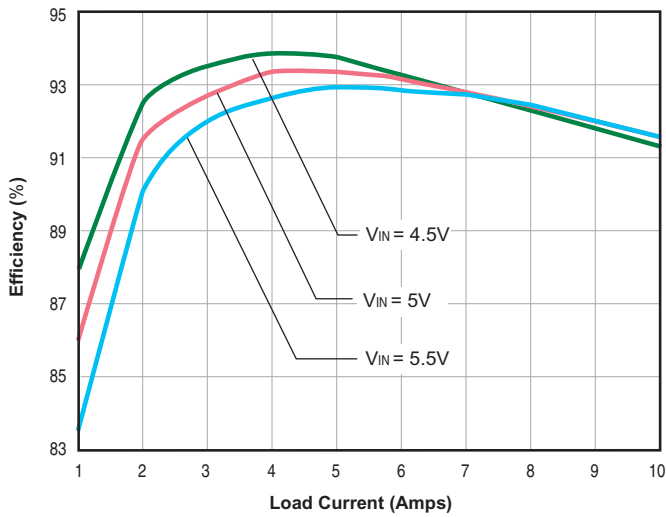

LSM-2.5/10-D5
Efficiency vs. Line Voltage and Load Current

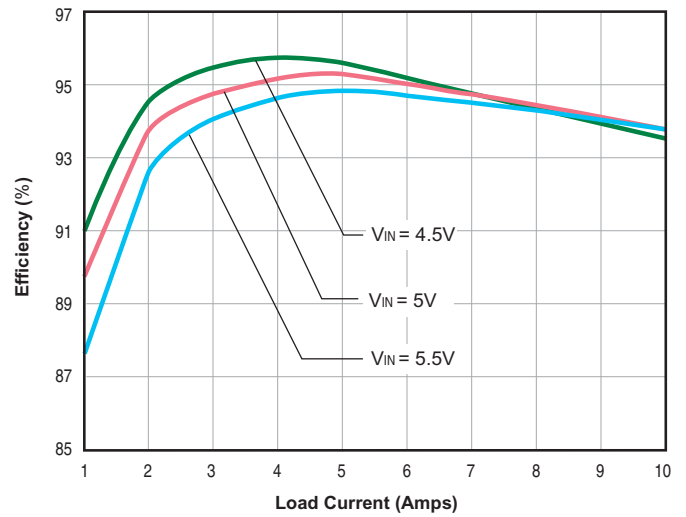

LSM-2/10-D5
Efficiency vs. Line Voltage and Load Current

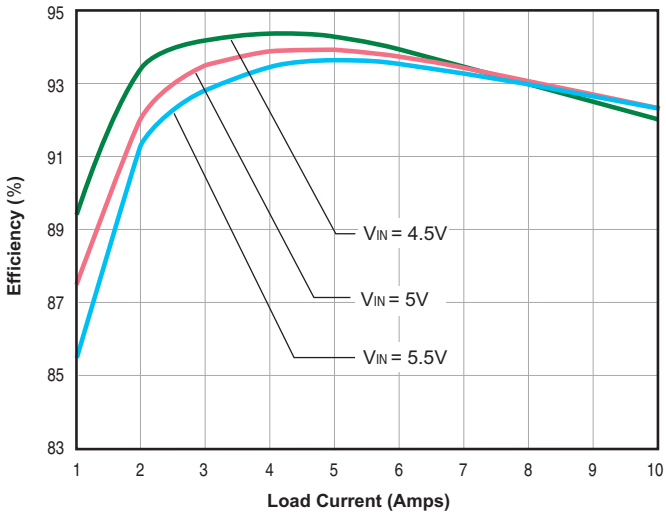

LSM-3.3/10-D5
Efficiency vs. Line Voltage and Load Current

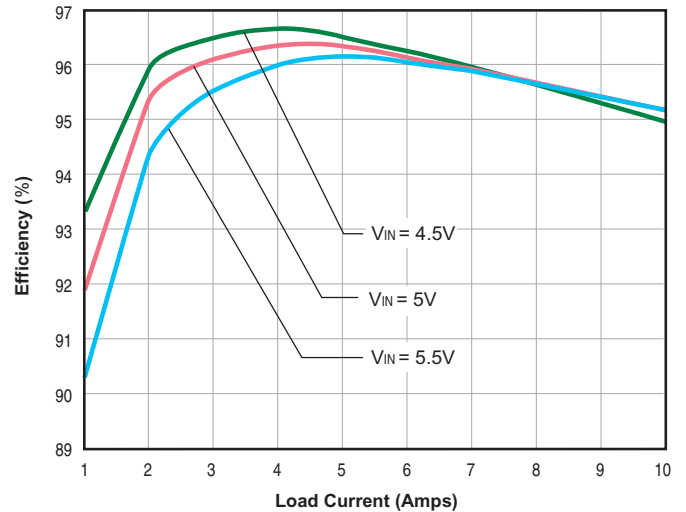

Typical Performance Curves for LSM-10A D5 SMT Series at VIN = 5V

Start-Up from ON/OFF
(IOUT = 1V/10A, CIN/COUT = 22μF)

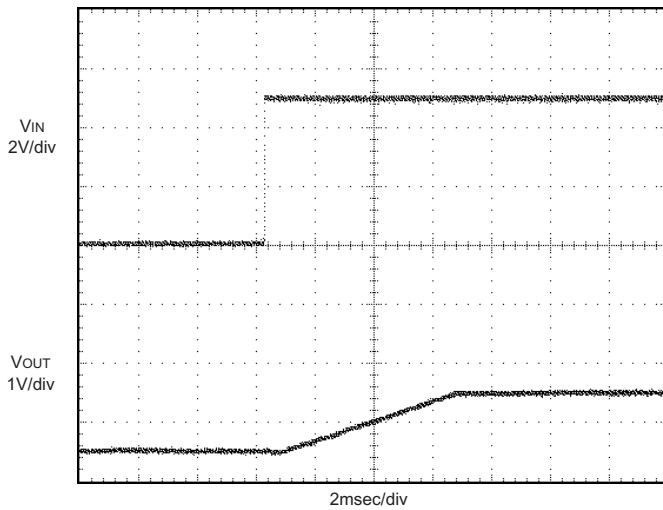

Start-Up from ON/OFF
(IOUT = 3.3V/10A, CIN/COUT = 22μF)

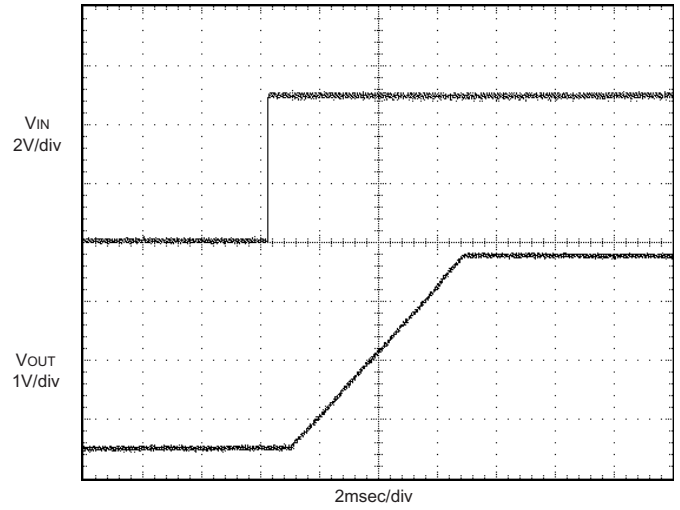

Start-Up from VIN
(IOUT = 1V/10A, CIN/COUT = 22μF)

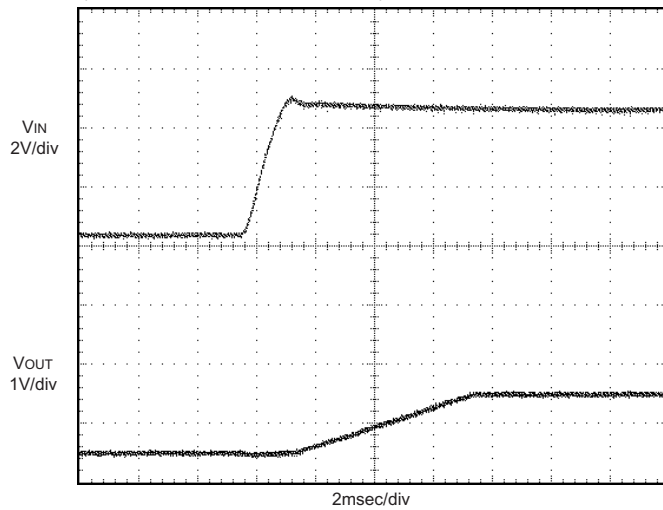

Start-Up from VIN
(IOUT = 3.3V/10A, CIN/COUT = 22μF)

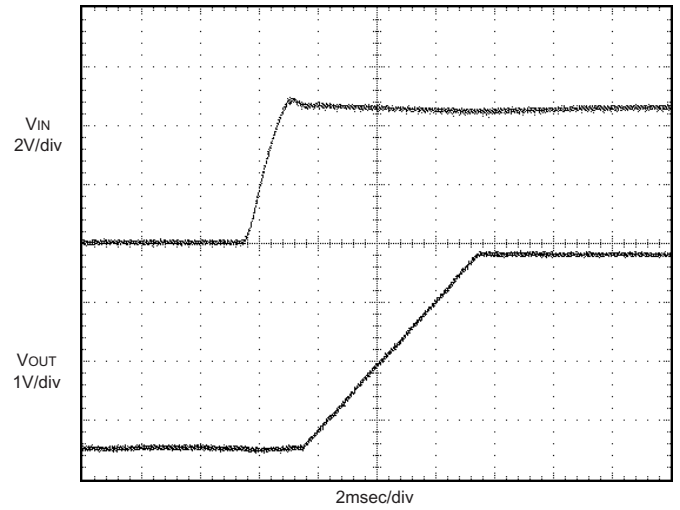

Input Reflected Ripple Current
(Input Filter = 220μF/12μH/33μF, IOUT = 3.3V/10A)

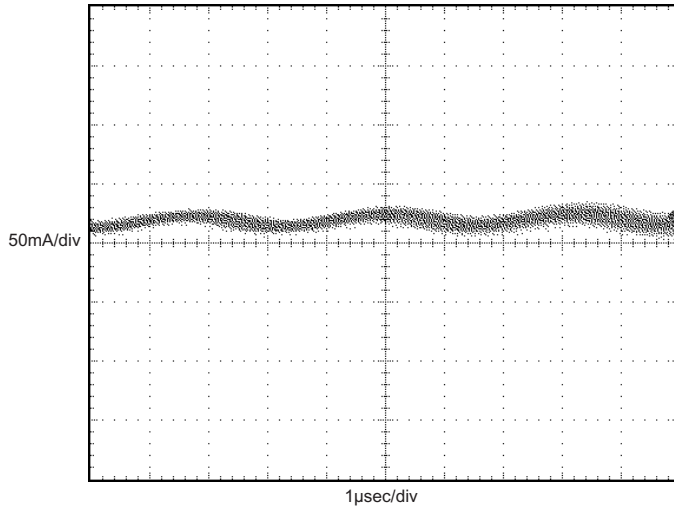

Output Hiccup
(LSM-3.3/10-D5 Shorted VOUT)

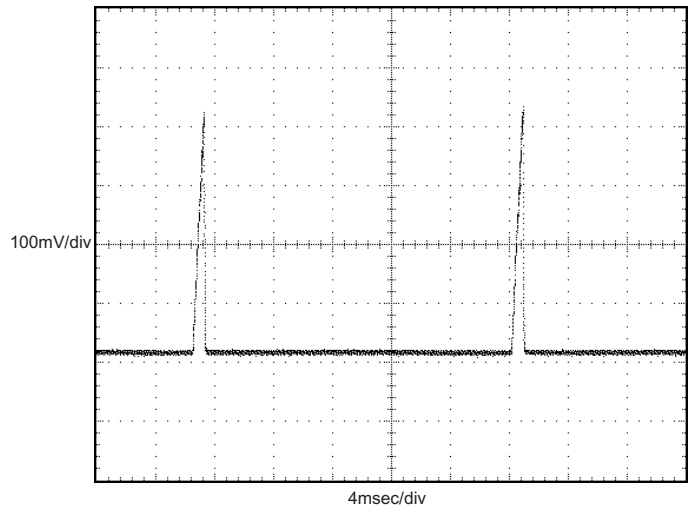

Typical Performance Curves for LSM-10A D5 SMT Series at VIN = 5V

Output Ripple and Noise

(VOUT = 3.3V/10A, CIN/COU = 22μF, BW = 20MHz)

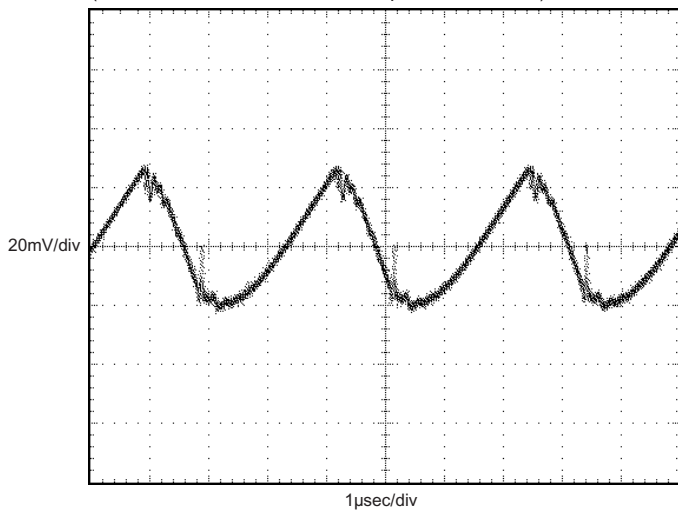

Output Ripple and Noise

(VOUT = 1V/10A, CIN/COU = 22μF, BW = 20MHz)

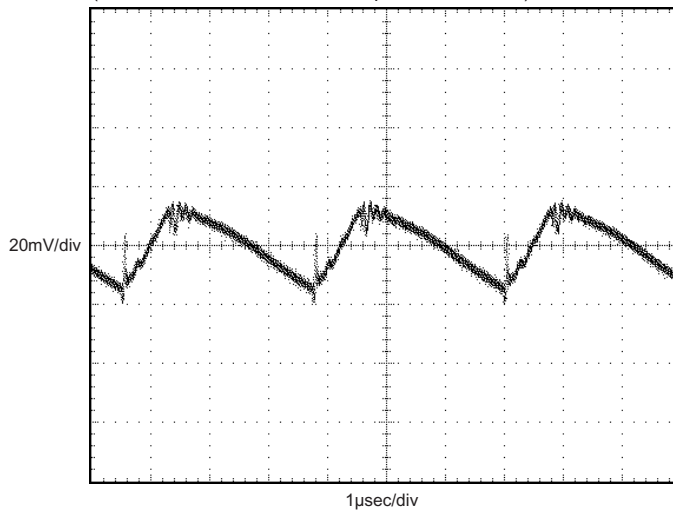

Dynamic Load Response

(VOUT = 3.3V, 0 to 10A Step, CIN/COU = 22μF)

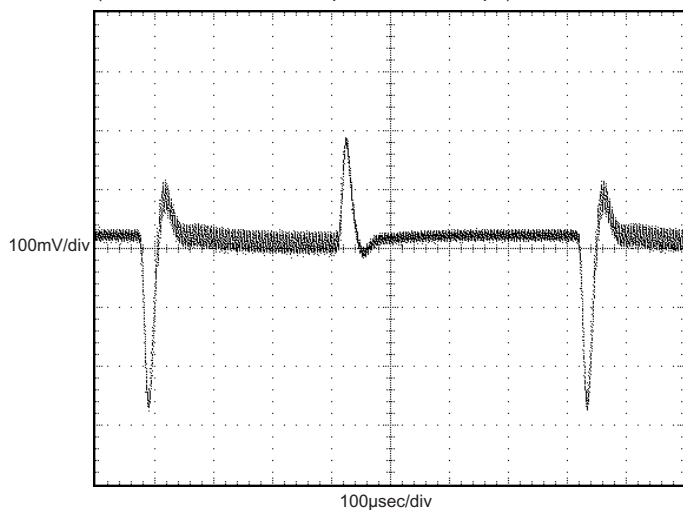

Dynamic Load Response

(VOUT = 3.3V, 0 to 10A Step, CIN = 22μF, COU = 1000μF Oscon)

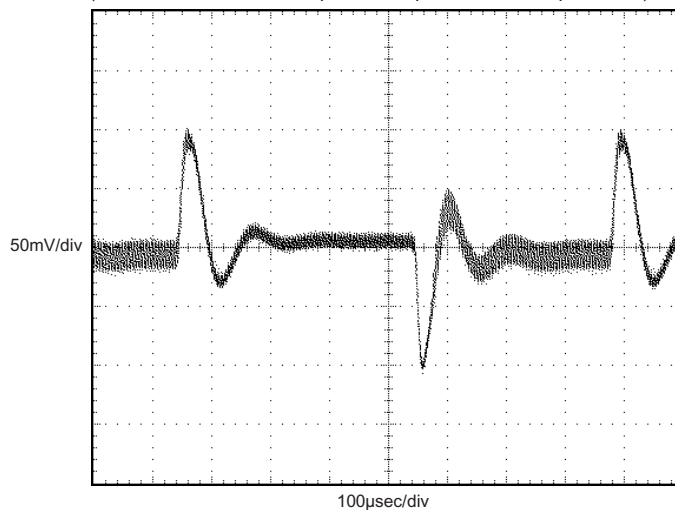

Dynamic Load Response

(VOUT = 1V, 5 to 10A Step, CIN/COU = 22μF)

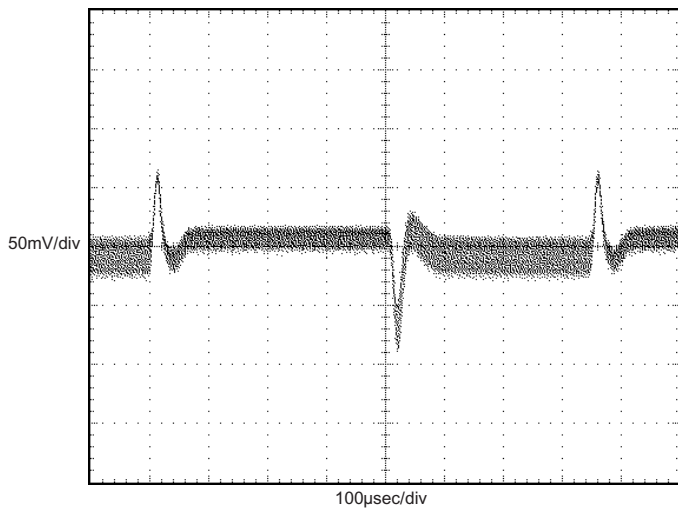

Dynamic Load Response

(VOUT = 1V, 5 to 10A Step, CIN = 22μF, COU = 1000μF Oscon)

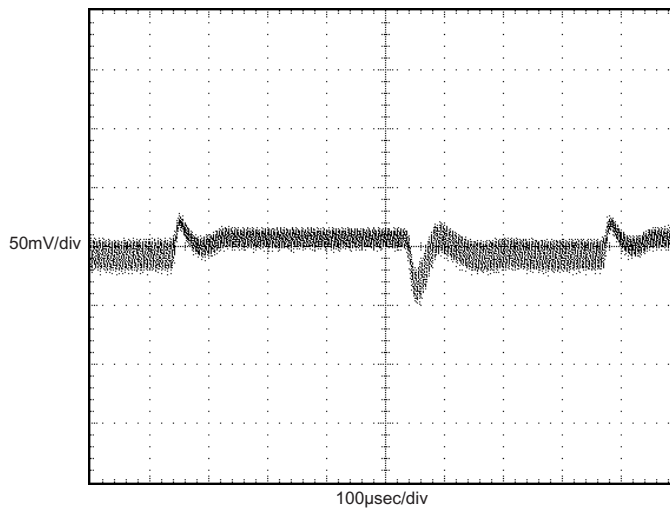

Tape & Reel Surface Mount Package

DATEL's LSM series DC/DC converters are the only higher-current (10A) SMT DC/DC's that can be automatically "pick-and-placed" using standard vacuum-pickup equipment (nozzle size and style, vacuum pressure and placement speed may need to be optimized for automated pick and place) and subsequently reflowed using high-temperature, lead-free solder.

Virtually all SMT DC/DC's today are unprotected "open-frame" devices assembled by their vendors with high-temperature solder (usually Sn96.5/Ag3.5 with a melting point +221°C) so that you may attach them to your board using low-temperature solder (usually Sn63/Pb37 with a melting point of +183°C). Conceptually straightforward, this "stepped" solder approach has its limitations, and it is clearly out of step with an industry trending toward the broad use of lead-free solders. Are you to experiment and develop reflow profiles from other vendors that ensure the components on those DC/DC never exceed 215-216°C? If those components get too hot, "double-reflow" could compromise the reliability of their solder joints. Virtually all these devices demand you "cool down" the Sn63 profile you are likely using today.

DATEL is not exempted from the Laws of Physics, and we do not have magic solders no one else has. Nevertheless, we have a simple and practical, straightforward approach that works. We assemble our LSM SMT DC/DC's using a high-temperature (+216°C), lead-free alloy (Sn96.2%, Ag2.5%, Cu0.8%, Sb0.5%). The LSM design ensures co-planarity to within 0.004 inches (100µm) of the unit's copper leads. These leads are gold-plated with a nickel underplate. See Mechanical Data for additional information.

The disposable heat shield (patent pending), which has a cutaway exposing the package leads, provides thermal insulation to internal components during reflow and its smooth surface ideally doubles as the vacuum pick-up location also. The insulation properties of the heat shield are so effective that temperature differentials as high as 50°C develop inside-to-outside the shield. Oven temperature profiles with peaks of 250-260°C and dwell times exceeding 2 minutes above 221°C (the melting point of Sn96.5/Ag3.5) are easily achieved.

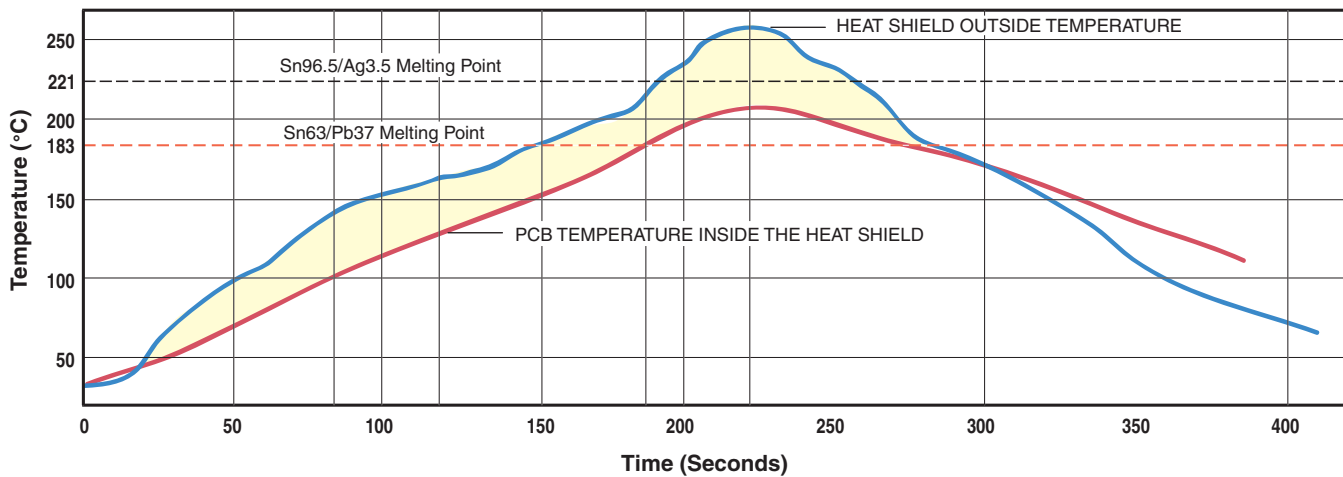
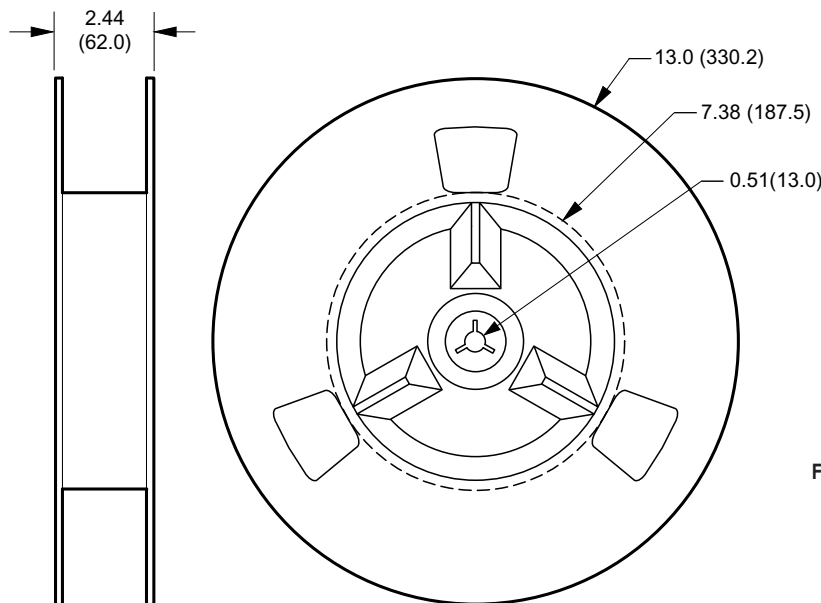
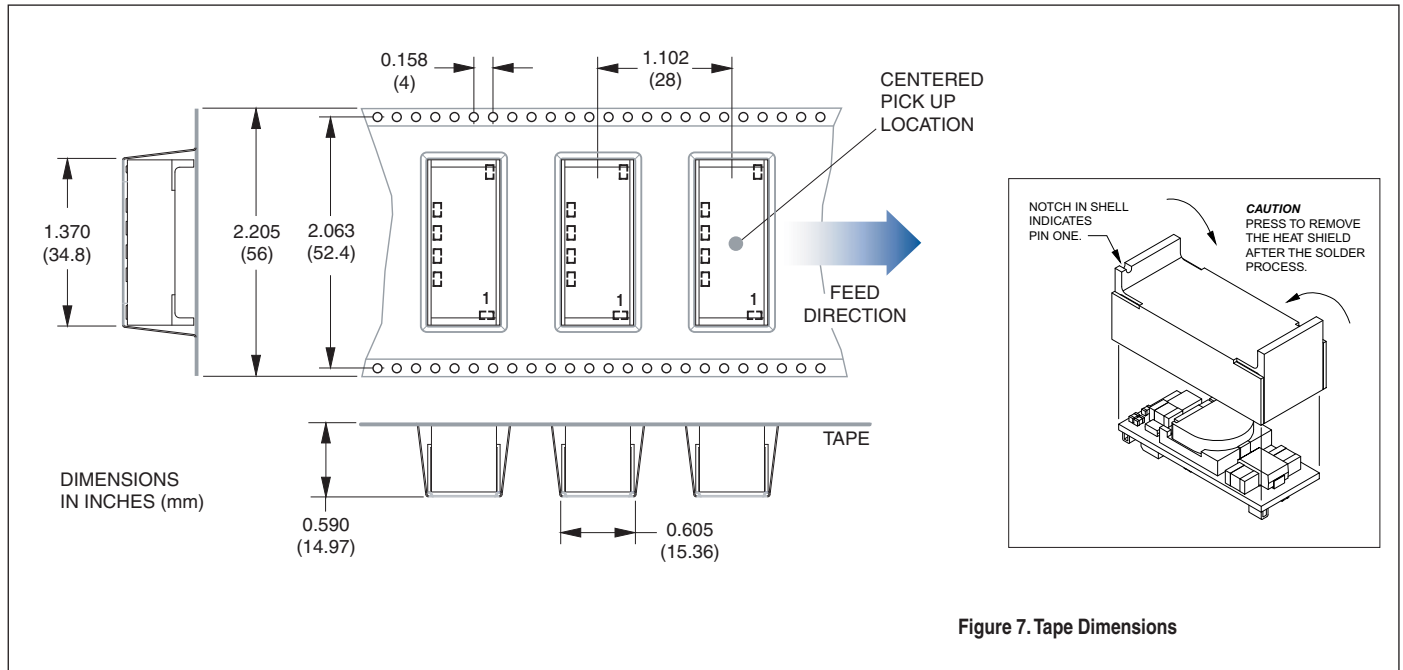

Figure 6. Reflow Solder Profile

DATEL's new-generation LSM SMT DC/DC converters are shipped in quantities of 150 modules per tape and reel.



Murata Power Solutions, Inc.
 11 Cabot Boulevard, Mansfield, MA 02048-1151 U.S.A.
 Tel: (508) 339-3000 (800) 233-2765 Fax: (508) 339-6356
www.murata-ps.com email: sales@murata-ps.com ISO 9001 REGISTERED

Murata Power Solutions, Inc. makes no representation that the use of its products in the circuits described herein, or the use of other technical information contained herein, will not infringe upon existing or future patent rights. The descriptions contained herein do not imply the granting of licenses to make, use, or sell equipment constructed in accordance therewith. Specifications are subject to change without notice.
 © 2008 Murata Power Solutions, Inc.

USA: Mansfield (MA), Tel: (508) 339-3000, email: sales@murata-ps.com
Canada: Toronto, Tel: (866) 740-1232, email: toronto@murata-ps.com
UK: Milton Keynes, Tel: +44 (0)1908 615232, email: mk@murata-ps.com
France: Montigny Le Bretonneux, Tel: +33 (0)1 34 60 01 01, email: france@murata-ps.com
Germany: München, Tel: +49 (0)89-544334-0, email: munich@murata-ps.com
Japan: Tokyo, Tel: 3-3779-1031, email: sales_tokyo@murata-ps.com
 Osaka, Tel: 6-6354-2025, email: sales_osaka@murata-ps.com
Website: www.murata-ps.jp
China: Shanghai, Tel: +86 215 027 3678, email: shanghai@murata-ps.com
 Guangzhou, Tel: +86 208 221 8066, email: guangzhou@murata-ps.com

04/08/08